

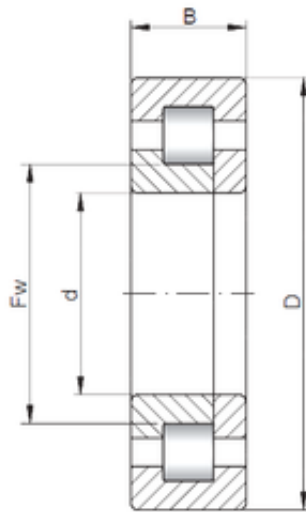

BEARING-MALAYSIA SDN.BHD.



480 mm x 650 mm x 78 mm ISO NUP1996
cylindrical roller bearings

Bearing No. NUP1996

Size	480x650x78 mm
Bore Diameter	480 mm
Outer Diameter	650 mm
Width	78 mm
d	480 mm
D	650 mm
B	78 mm
C	78 mm

NUP1996 Bearing 2D drawings and 3D CAD models